



SCW70M

User Manual

Please read the instructions carefully
before installation and use.

1. General Description

1.1 Ultra-fast Maximum Power Point Tracking (MPPT)

Especially in case of a clouded sky, when light intensity is changing continuously, an ultra fast MPPT controller will improve energy harvest by up to 30% compared to PWM charge controllers and by up to 10% compared to slower MPPT controllers.

1.2 Advanced Maximum Power Point Detection in case of partial shading conditions

If partial shading occurs, two or more maximum power points may be present on the power-voltage curve. Conventional MPPT's tend to lock to a local MPP, which may not be the optimum MPP.

The innovative **Voltech** algorithm will always maximize energy harvest by locking to the optimum MPP.

1.3 Outstanding conversion efficiency

No cooling fan. Maximum efficiency exceeds 98%. Full output current up to 40°C (104°F).

1.4 Flexible charge algorithm

Eight preprogrammed algorithms, selectable with a rotary switch.

1.5 Extensive electronic protection

Over-temperature protection and power derating when temperature is high.
PV short circuit and PV reverse polarity protection.
PV reverse current protection.

1.6 Internal temperature sensor

Compensates absorption and float charge voltages for temperature.

1.7 Automatic battery voltage recognition

The controllers will automatically adjust to a 12V, 24V or a 48V system. The 36V system must be set by the factory.

1.8 Adaptive three step charging

The **Voltech** MPPT Solar Charge Controller is configured for a three step charging process: Bulk – Absorption - Float. A regular equalization charge can also be programmed: see section 3.8 of this manual.

1.8.1. Bulk stage

During this stage the controller delivers as much charge current as possible to rapidly recharge the batteries.

1.8.2. Absorption stage

When the battery voltage reaches the absorption voltage setting, the controller switches to constant voltage mode.

When only shallow discharges occur the absorption time is kept short in order to prevent overcharging of the battery. After a deep discharge the absorption time is automatically increased to make sure that the battery is completely recharged. Additionally, the absorption period is also ended when the charge current decreases to less than 2 A.

1.8.3. Float stage

During this stage, float voltage is applied to the battery to maintain it in a fully charged state.

2. Safety instructions

- please read this manual carefully before the product is installed and put into use.
- This product is designed and tested in accordance with international standards. The equipment should be used for the designated application only.
- Install the product in a heatproof environment. Ensure therefore that there are no chemicals, plastic parts, curtains or other textiles, etc. in the immediate vicinity of the equipment.
- Ensure that the equipment is used under the correct operating conditions. Never operate it in a wet environment.
- Never use the product at sites where gas or dust explosions could occur.
- Ensure that there is always sufficient free space around the product for ventilation.
- Refer to the specifications provided by the manufacturer of the battery to ensure that the battery is suitable for use with this product. The battery manufacturer's safety instructions should always be observed.
- Protect the solar modules from incident light during installation, e.g. cover them.
- Never touch uninsulated cable ends.
- Use only insulated tools.
- Connections must always be made in the sequence described in section 3.5.
- The installer of the product must provide a means for cable strain relief to prevent the transmission of stress to the connections.
- In addition to this manual, the system operation or service manual must include a battery maintenance manual applicable to the type of batteries used.

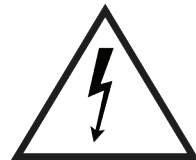

WARNING

**danger of explosion from
sparking danger of electric
shock**

3. Installation

3.1 General

- Mount vertically on a non-flammable surface, with the power terminals facing downwards.
- Mount close to the battery, but never directly above the battery (in order to prevent damage due to gassing of the battery).
- Grounding: the heatsink of the controller should be connected to the grounding point.

The maximum diameter of the individual strands is 0,4 mm/0,125 mm² (0.016 inch/AWG26).

A 25 mm² cable, for example, should have at least 196 strands(class 5 or higher stranding according to VDE 0295, IEC 60228 and BS6360). Also known as H07V-K cable.

An AWG2 gauge cable should have at least 259/26 stranding(259 strands of AWG26).

In case of thicker strands the contact area will be too small and the resulting high contact resistance will cause severe overheating, eventually resulting in fire.

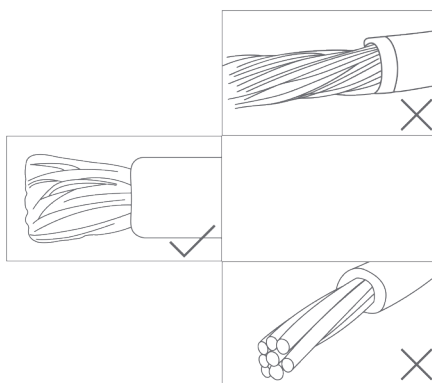

3.2 PV configuration

- The controllers will operate only if the PV voltage exceeds battery voltage (Vbat).
- PV voltage must exceed Vbat + 5V for the controller to start. Thereafter minimum PV voltage is Vbat + 1V.
- Maximum open circuit PV voltage: 150V.

The controllers can be used with any PV configuration that satisfies the three above mentioned conditions.

For example: 24V battery and mono- or polycrystalline panels

- Minimum number of cells in series: 72 (2x 12V panel in series or one 24V panel).
- Recommended number of cells for highest controller efficiency: 144 cells (4x 12V panel or 2x 24V panel in series).
- Maximum: 216 cells (6x 12V or 3x 24V panel in series).
- 48V battery and mono- or polycrystalline panels
- Minimum number of cells in series: 144 (4x 12V panel or 2x 24V panel in series).
- Maximum: 216 cells.

Remark: at low temperature the open circuit voltage of a 216 cell solar array may exceed 150 V, depending on local conditions and cell specifications. In that case the number of cells in series must be reduced.

3.3 Cable connection sequence (see figure 1)

First: connect the battery.

Second: connect the solar array (when connected with reverse polarity, the controller will heat up but will not charge the battery).

3.4 More about automatic battery voltage recognition

The system voltage is stored in non volatile memory.

In case of a 24 V or 48 V battery, a reset (to 12 V) occurs only when the output voltage decreases to less than 2 V and the voltage on the PV input exceeds 7 V. This may occur when the battery has been disconnected before PV voltage starts to rise in the early morning. When the (24 V or 48 V) battery is reconnected later during the day, the system voltage is restored to 24 V resp. 48 V after 10 seconds if the battery voltage exceeds 17,5 V resp. 35 V.

Automatic voltage recognition can be switched off and a fixed 12/24/36 or 48 V system voltage .

The controller can be reset by short circuiting the output and applying a voltage exceeding 7 V on the input (for example with a small power supply, or a solar panel) during a few seconds. After a reset, the MPPT solar charge controller will automatically adjust itself to a 12V system, a 24V system (when connecting a 24 V battery with at least 17,5 V) or a 48V system (when connecting a 48 V battery with at least 35 V). The 36V system must be set by the factory.

3.5 Configuration of the MPPT solar charge controller

Fully programmable charge algorithm (see the software page on our website) and eight preprogrammed charge algorithms, selectable with a rotary switch:

Note (*3): E.g. calibration and/or settings data lost, current sensor issue.

Pos	Suggested battery type	Absorption V	Float V	Equalize V @%/Inm	dV/dT mV/°C
0	Gel long life (OPzV) Gel exide A600 (OPzV) Gel MK	28,2	27,6	31,8@8%	-32
1	Gel deep discharge Gel Exide A200 AGM deep discharge Stationary tubular plate (OPzS) Rolls Marine (flooded) Rolls Solar (flooded)	28,6	27,6	32,2@8%	-32
2	Default setting Gel deep discharge Gel Exide A200 AGM deep discharge Stationary tubular plate (OPzS) Rolls Marine (flooded) Rolls Solar (flooded)	28,8	27,6	32,4@8%	-32
3	AGM spiral cell Stationary tubular plate (OPzS) Rolls AGM	29,4	27,6	33,0@8%	-32
4	PzS tubular plate traction batteries or OPzS batteries	29,8	27,6	33,4@25%	-32
5	PzS tubular plate traction batteries or OPzS batteries	30,2	27,6	33,8@25%	-32
6	PzS tubular plate traction	30,6	27,6	34,2@25%	-32
7	Lithium Iron Phosphate (LiFePo 4) batteries	28,4	27,0	n.a.	0

3.6 Battery charging information

The MPPT solar charge controller starts a new charge cycle every morning, when the sun starts shining. The maximum duration of the absorption period is determined by the battery voltage measured just before the solar charger starts up in the morning:

Battery voltage V_b (@start-up)	Maximum absorption time
$V_b < 23,8V$	6h
$23,8V < V_b < 24,4V$	4h
$24,4V < V_b < 25,2V$	2h
$V_b > 25,2V$	1h

(divide voltages by 2 for a 12 V system and multiply by two in case of a 48V system)

If the absorption period is interrupted due to a cloud or due to a power hungry load, the absorption process will resume when absorption voltage is reached again later on the day, until the absorption period has been completed.

The absorption period also ends when the output current of the solar charger drops to less than 2 Amps, not because of low solar array output but because the battery is fully charged (tail current cut off).

This algorithm prevents over charge of the battery due to daily absorption charging when the system operates without load or with a small load.

3.6.1 Automatic equalization

Automatic equalization is default set to "OFF". The automatic equalization function only setting in factory.

4 Setting and display

SETUP	Cancel / back
SELECT	Select / confirm
	Change item or value
On	There is a connection with the MPPT solar charge controller.
Blinking	There was a connection with the MPPT solar charge controller but the connection is lost. The last know values will be shown.
Off	There has not been a connection with a MPPT solar charge controller.











Navigation Status

This shows the current status of the MPPT solar charge controller.

By pressing the up and down button, one can switch between the following values:

	PANEL POWER	
	PANEL VOLTAGE	
	YIELD TODAY	
	CHARGER ERROR	This is only visible when there is an actual error
	CHARGER STATE	Possible value: OFF, FAULT, BULK, ABSORPTION, FLOAT
	BATTERY CURRENT	
	BATTERY VOLTAGE	

History





By pressing SELECT in the status menu, the history menu is entered. Here, the history stored in the MPPT solar charge controller can be viewed. This contains both overall history and well as a day to day history. This is a 30 day history.

When viewing values, one can select a different day by pressing the up and down button. The MPPT solar charge controller will first show the value for a short time, then the currently selected day, and then the value again. When viewing an overall history value, pressing the up or down button will cause the MPPT solar charge controller to show "TOTAL".











Pressing SETUP causes the MPPT solar charge controller to go back to the status menu topics when viewing topics or go back to the topics menu when viewing values.

The topics are listed in the table below.
 Only topics marked with a * are visible in case of 2 day history.

Overall topics

	TOTAL YIELD*	The cumulative yield since the last history reset
	MAX PANEL VOLTAGE	The maximum panel voltage since the last history reset
	MAX BATTERY VOLTAGE	The maximum battery voltage since the last history reset
	MIN BATTERY VOLTAGE	The minimum battery voltage since the last history reset. (Only available for MPPT solar charge controller software version >= 1.17)
	LAST ERRORS	The last 4 errors since the last history reset. The number of blocks in the lower right of the screens determines which error is currently shown with 1 block being the latest and 4 blocks being the oldest.

Daily topics

	YIELD*	The daily yield
	MAX POWER*	The maximum power per day
	MAX PANEL VOLTAGE	The maximum panel voltage per day
	MAX BATTERY CURRENT	The maximum battery current per day
	MAX BATTERY VOLTAGE	The maximum battery voltage per day
	MIN BATTERY VOLTAGE	The minimum battery voltage per day
	BULK TIME	The time spend in bulk per day
	ABSORPTION TIME	The time spend in absorption per day
	FLOAT TIME	The time spend in float per day
	LAST ERROR	The last 4 errors per day. The number of blocks in the lower right of the screens determines which error is currently shown.

Settings

By pressing SETUP for 2 seconds in the status menu, the settings menu is entered. Here, the MPPT solar charge controller setting can be viewed and changed. First the topic is shown and when SELECT is pressed, the corresponding value is shown. When SELECT TO EDIT is OFF, the value is shown before it can be changed by pressing SELECT again. When SELECT TO EDIT is ON, the current value is shown and a new value can immediately be selected. When LOCK SETUP is ON, settings only be changed after setting LOCK SETUP to off.

When editing a value, one can change its value by pressing the up and down buttons. When changing numeric values, pressing SELECT will go to the next digit, until the last digit. In this case, pressing SELECT will save the setting. When editing non numeric values, pressing SELECT will save the setting. Pressing SETUP causes the MPPT solar charge controller to go back to the status menu topics when viewing topics or go back to the topics menu when viewing values.

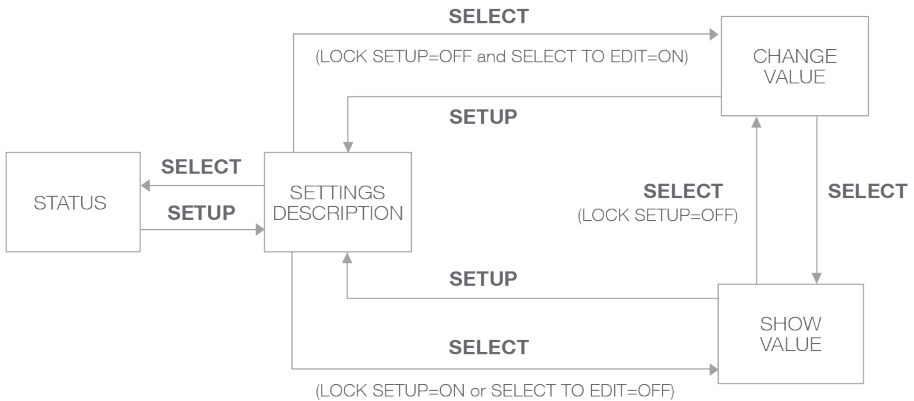

The settings are listed in the table below.

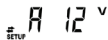
01 LOCK SETUP	When this is ON, other settings cannot be changed. When trying to change a setting (except LOCK SETUP), the MPPT solar charge controller will show "LOCK" and show the value of that setting.
02 BATTERY VOLTAGE	The battery voltage that the MPPT solar charge controller is working with. When the setting is AUTO, it will show the A character in front of the voltage. 
03 BATTERY TYPE	The battery type that the MPPT solar charge controller is working with. This can be set to FIXED or USER. When set to fixed, the rotary switch on the MPPT solar charge controller determines the actual battery type. When set to USER, all other charging related settings can be edited. It will be automatically set to USER when editing a charger related setting.
04 MAXIMUM CURRENT	The maximum charging current
05 BULK TIME LIMIT	The maximum time continuously spent in bulk
06 ABSORPTION TIME LIMIT	The maximum time continuously spent in absorption
07 ABSORPTION VOLTAGE	Battery voltage at which the MPPT solar charge controller switches to the absorption phase
08 FLOAT VOLTAGE	Battery voltage at which the MPPT solar charge controller switches to the float phase
09 TEMP COMPENSATION	
13 CLEAR HISTORY	Clears the history of the MPPT solar charge controller
14 FACTORY DEFAULTS	Resets the MPPT solar charge controller back to factory defaults
15 BACKLIGHT INTENSITY	Sets the backlight intensity of the LCD
16 BACKLIGHT ALWAYS ON	Determines whether the backlight of the LCD always on
17 SCROLL SPEED	Determines the scroll speed of the LCD
18 SELECT TO EDIT	When set to OFF, the MPPT solar charge controller first shows the value of a setting and SELECT has to be pressed to be able to edit the value
19 AUTO LOCK	When set to ON, LOCK SETUP will be automatically set to ON, 2 minutes after changing a setting.

5. Troubleshooting

Problem	Possible cause	Solution
Charger does not function	Reversed PV connection	Connect PV correctly
	Reverse battery connection	Non replacable fuse blown.Return to VE for repair
The battery is not fully charged	A bad battery connection	Check battery connection
	Cable losses too high	Use cables with larger cross section
	Large ambient temperature difference between charger and battery (T ambient_chrg > T ambient_batt)	Make sure that ambient conditions are equal for charger and battery
	Only for a 24V system: wrong system voltage chosen (12V instead of 24V) by the MPPT solar charge controller	Disconnect PV and battery, after making sure that the battery voltage is at least >19V, reconnect properly (reconnect battery first)
The battery is being overcharged	A battery cell is defect	Replace battery
	Large ambient temperature difference between charger and battery (T ambient_chrg < T ambient_batt)	Make sure that ambient conditions are equal for charger and battery

Dimension drawing

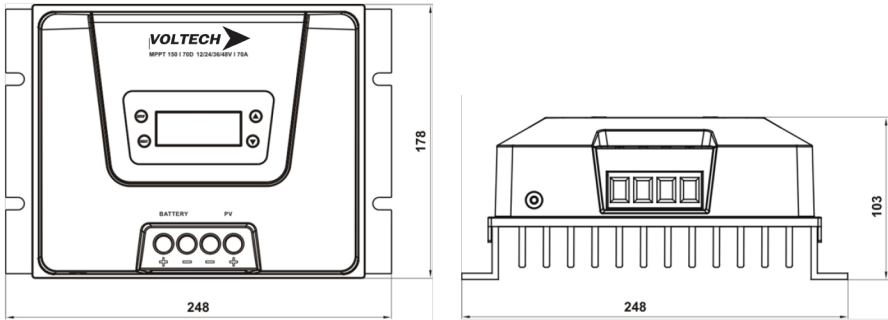

6 . Specifications

Solar charge controller	SCW45M	SCW60M	SCW70M
Battery voltage	12/24/48 V Auto Select (36 V: must be set by the factory.)		
Maximum battery current	45 A	60A	70A
Maximum PV power, 12V 1a,b)	650 W	860 W	1000 W
Maximum PV power, 24V 1a,b)	1300 W	1720 W	2000 W
Maximum PV power, 48V 1a,b)	2600 W	3440 W	4000 W
Maximum PV open circuit voltage	150 V		
Peak efficiency	Peak efficiency 98 %		
Self consumption	Less than 35 mA @ 12 V / 20 mA @ 48 V		
Charge voltage 'absorption'	Default setting: 14,4 V / 28,8 V / 57,6 V (adjustable)		
Charge voltage 'equalization'	Default setting: 16,2 V / 32,4 V / 64,8 V (adjustable)		
Charge voltage 'float'	Default setting: 13,8 V / 27,6 V / 55,2 V (adjustable)		
Charge algorithm	multi-stage adaptive (eight preprogrammed algorithms)		
Temperature compensation	-16 mV/°C / -32 mV/°C / -64 mV/°C		
Protection	Battery reverse polarity (fuse, not user accessible) Output short circuit / Over temperature		
Operating temperature	-30 to +60°C (full rated output up to 40°C)		
Humidity	95 %, non-condensing		
Maximum altitude	2000m		
Environmental condition	Indoor, unconditioned		
Pollution degree	PD3		
Synchronized parallel operation	Not possible		
ENCLOSURE			
PV terminals 2)	35 mm ² / AWG2		
Battery terminals	35 mm ² / AWG2		
Protection category	IP43 (electronic components) /IP 22 (connection area)		
Weight	2.6kg		
Dimensions (h x w x d)	248 x 178 x 103 mm		
STANDARDS			
Safety	EN/IEC 62109		

1a) If more PV power is connected, the MPPT solar charge controller will limit input power to the maximum power.
 1b) PV voltage must exceed Vbat + 5V for the MPPT solar charge controller to start.
 Thereafter minimum PV voltage is Vbat + 1 V.

www.electroparts.com.au

Electro Parts Australia Pty Ltd 51 Southlink Street, Parkinson QLD 4115 Tel (07) 3219 6655