

COTEK

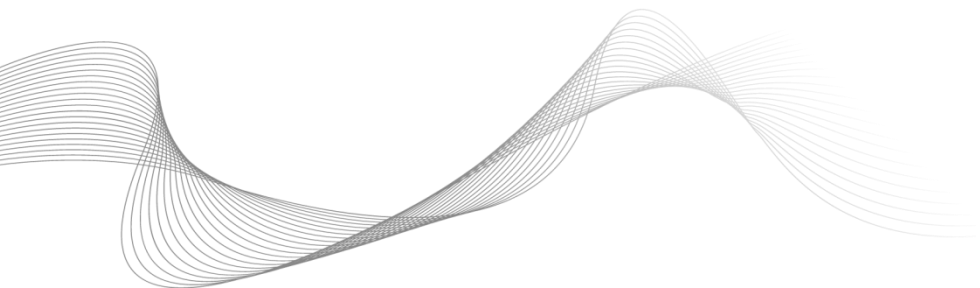

SP Series User's Manual

SP-700/1000/1500/2000/3000/4000

PURE SINE WAVE INVERTER

Table of Content

1. SAFETY INSTRUCTIONS	1
1-1. General Safety Precautions	1
1-2. Other Safety Notes	1
2. FUNCTIONAL CHARACTERISTICS INTRODUCTION	3
2-1. System	3
2-2. Block Diagram	3
2-3. Electrical Specification	4
2-3-1. SP-700 Specification	4
2-3-2. SP-700 Specification	5
2-3-3. SP-1000 Specification	7
2-3-4. SP-1000 Specification	8
2-3-5. SP-1500 Specification	10
2-3-6. SP-1500 Specification	11
2-3-7. SP-2000 Specification	13
2-3-8. SP-2000 Specification	14
2-3-9. SP-3000 Specification	16
2-3-10. SP-3000 Specification	17
2-3-11. SP-4000 Specification	19
2-3-12. SP-4000 Specification	20
2-3-13. Voltage & temperature performance	22
2-4. Mechanical Drawings	23
3. INSTALLATION AND MAINTENANCE	24
3-1. AC Output Side (Front Panel) Introduction	24
3-1-1. Main Switch	25
3-1-2. LED Indicator	25
3-1-3. Function Switch Introduction	26

3-1-4. TRC Port (for optional kits TR-40, RJ-45)	27
3-1-5. AC output Interface	28
3-2. DC Input Side (Rear Panel) Introduction	29
3-2-1. Remote Port (RJ-11)	31
3-2-2. Remote Control Green Terminal	31
3-2-3. General instruction before DC Input ④	32
3-2-4. Chassis Ground ③	33
3-3. Maintenance	33
4. OPERATION	34
4-1. Connection the DC cable	34
4-2. Connecting the input power	35
4-3. Connecting the loads	35
4-4. Switch ON Inverter	35
4-5. Protection Mechanism	36
5. RS-232 COMMUNICATION AND OPERATION	36
5-1. RS232 Port	36
5-2. RS232 Port Operating	37
5-3. Example of RS232 Port Operating	37
5-3-1. RS232 command format	37
5-3-2. Command format	38
6. INFORMATION	41
6-1. Warning	41
6-2. Warranty	41

1. Safety Instructions

1-1. General Safety Precautions



Warning! Before using the Inverter, read the safety instructions.

- Do not expose the inverter to rain, snow, spray or dust. To reduce the risk of fire hazard, do not cover or obstruct the ventilation openings and do not install the inverter in a zero-clearance compartment.
- To avoid the risk of fire and electric shock, make sure that the existing wiring is in good electrical condition, and the wire size is not undersized.
- This equipment contains components which can produce arcs or sparks. To prevent fire or explosion do not install in compartment containing batteries or flammable materials or in location which require ignition protected equipment. This includes any space containing gasoline-powered machinery, fuel tanks, or joints, fittings, or other connection between components of the fuel system.
- Depending on the user scenario, the AC output of the inverter may require user installed breaker or fuse. In AC output hardwire application, AC socket will not be provided. The inverter incorporates standard AC short circuit protection.
- The following precautions should be taken when working on the inverter:
 - Step 1 Remove watches, rings, or other metal objects
 - Step 2 Use tools with insulated handles
 - Step 3 Wear rubber gloves and boots

1-2. Other Safety Notes

- Upon receipt, examine the carton box for damage. If you have found any damage on the carton box please notify the company you purchased this unit from.

-
- Do not operate near water or in excessive humidity.
 - Do not open or disassemble the inverter, and warranty may be voided.
 - The DC side connections should be firm and tight.
 - Grounding: Reliable grounding should be maintained.
 - Do not drop a metal tool on the battery. The resulting spark or short-circuit on the battery or on the other electrical part may cause an explosion.
 - Install the inverter in a well-ventilated area. Do not block the front air vents, or the rear air exhausts of the unit.
 - Wiring: Adequate input power must be supplied to the inverter for proper use; correct wiring sizes must be ensured.
 - Mount the inverter such that the fan axis is horizontal.
 - Do not operate the inverter close to combustible gas or open fire.
 - Do not operate appliances that may feed power back into the inverter.
 - Temperature: The inverter should be operated in an ambient temperature range of -20°C to 40°C otherwise the output efficiency may be affected. Air flow to the inverter must not be blocked.

2. Functional Characteristics Introduction

2-1. System

The unit is a highly reliable DC-AC inverter system, designed with advanced power electronic and microprocessor technology offering the following features:

- Pure sine wave output (THD < 5%) to operate
- Optional bypass relay(TR-40) function
- Intelligent software for power management
- Loading and temperature controlled cooling fan
- CR-8/CR-16 remote management and control
- RS232 communication
- Dry contact terminal
- Advanced Protection Features
 - Input over/under voltage protection
 - Internal over temperature protection
 - Input reverse polarity protection (Fuse)
 - Output overload protection
 - Output short circuit protection

2-2. Block Diagram

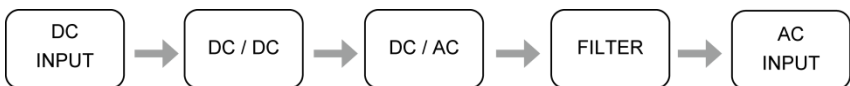

2-3. Electrical Specification

2-3-1. SP-700 Specification

Electrical	Specification	Model No.		
	Item	SP-700-112	SP-700-124	SP-700-148
Input Characteristics	Voltage	12VDC	24VDC	48VDC
	Input Over-Voltage Protection	16.5 ± 0.3VDC	33 ± 0.5VDC	66 ± 1.0VDC
	Input Under-Voltage Protection	10.5 ± 0.3VDC ^①	21 ± 0.5VDC ^①	42 ± 1.0VDC ^①
	Voltage Range	10.5~16.5VDC	21~33VDC	42~66VDC
	No Load Current	<1.5 A @12VDC	<0.8 A @24VDC	<0.5 A @48VDC
	Power Saving Mode	<0.1A @12VDC	<0.06A @24VDC	<0.05A @48VDC
Output Characteristics	Continuous Output Power	700 VA (± 3%)		
	Maximum output Power (1Min)	> 700 VA~810 VA (100%~115%)		
	Surge Power (1Sec)	< 1230 VA		
	Frequency	50 / 60 Hz ± 0.5% (Dip Switch Selectable)		
	Output Voltage	100 / 110 / 115 / 120 VAC (± 5%) (Dip Switch Selectable)		
	Efficiency max.	88%	89%	90%
	Short-Circuit Protection	1 Sec Shutdown		
	Output Waveform	Pure Sine Wave (THD < 5% @ Normal Load) ^②		
Signal and Control	Remote Controller Panel Unit	CR-8 / CR-16 (optional)		
	LED Indicator	Red / Orange / Green LED		
	Dry Contact Terminal	By a relay		
	Remote Control Terminal	6-port Green terminal (for inverter ON / OFF)		
Protection	Input Protection	Over / Under Voltage, Reverse Polarity (Internal Fuse)		
	AC Output Protection	Short-Circuit, Overload		
	Others	Over / Under Temperature Protection (by Heat sink Temperature +80℃/-20℃)		
Environment	Operating Temp.	-20 ℃~40 ℃ ^③		
	Storage Temp.	-30 ℃~70 ℃		
	Storage Temp. & Humidity	10 ~95% RH		

Electrical	Specification	Model No.		
	Item	SP-700-112	SP-700-124	SP-700-148
Safety & EMC	Safety Standards	Certified UL 458 (UL only for GFCI receptacles)		----
	EMC standards	Certified FCC class B		
	E-mark	----		
Dimension(WxHxD)		200mm X 83mm X 330mm		
Weight		2.6 KG		
Cooling		Temperature & Load Controlled cooling Fan		
AC Transfer Function Accessories		TR-40 (optional)		

Table 1. SP-700 for Output 100/110/115/120 VAC Specification.



Note :

- ① Voltage range : Please refer to Figure 1
- ② Normal load Condition : $V_{in} = 12.5V/25V/50V$,
 $V_o = 100/110/115/120 \text{ VAC}$ 80% Full load (PF=1.0)
- ③ Operating temperature : Please refer to Figure 2

2-3-2. SP-700 Specification

Electrical	Specification	Model No.		
	Item	SP-700-212	SP-700-224	SP-700-248
Input Characteristics	Voltage	12VDC	24VDC	48VDC
	Input Over-Voltage Protection	$16.5 \pm 0.3VDC^{\text{①}}$	$33 \pm 0.5VDC^{\text{①}}$	$66 \pm 1.0VDC^{\text{①}}$
	Input Under-Voltage Protection	$10.5 \pm 0.3VDC$	$21 \pm 0.5VDC$	$42 \pm 1.0VDC$
	Voltage Range	10.5~16.5VDC	21~33VDC	42~66VDC
	No Load Current	<1.5 A @12VDC	<0.8A @24VDC	<0.5 A @48VDC
	Power Saving Mode	<0.1 A @12VDC	<0.06A @24VDC	<0.05 A @48VDC
Output Characteristics	Continuous Output Power	700 VA ($\pm 3\%$)		
	Maximum output Power (1Min)	> 700 VA~810 VA (100%~115%)		
	Surge Power (1Sec)	< 1230 VA		
	Frequency	50 / 60 Hz $\pm 0.5\%$ (Dip Switch Selectable)		
	Output Voltage	200 / 220 / 230 / 240 VAC ($\pm 3\%$) (Dip Switch Selectable)		

Electrical	Specification	Model No.		
	Item	SP-700-212	SP-700-224	SP-700-248
Output Characteristics	Efficiency max.	88%	89%	90%
	Short-Circuit Protection	1 Sec Shutdown		
	Output Waveform	Pure Sine Wave (THD < 5% @ Normal Load) [®]		
Signal and Control	Remote Controller Panel Unit	CR-8 / CR-16 (optional)		
	LED Indicator	Red / Orange / Green LED		
	Dry Contact Terminal	By a relay		
	Remote Control Terminal	6-port Green terminal (for inverter ON / OFF)		
Protection	Input Protection	Over / Under Voltage, Reverse Polarity (Internal Fuse)		
	AC Output Protection	Short-Circuit, Overload		
	Others	Over / Under Temperature Protection (by Heat sink Temperature +80°C/-20°C)		
Environment	Operating Temp.	-20 °C ~40 °C [®]		
	Storage Temp.	-30 °C ~70 °C		
	Storage Temp. & Humidity	10 ~95% RH		
Safety & EMC	Safety Standards	Certified EN 60950-1		
	EMC standards	Certified EN 55022; EN 55024; EN 61000-3-2, -3-3 EN 61000-4-2, 3, 4, 5, 6, 8, 11		
	E-mark	Certified CISPR 25; ISO 11452-2; ISO 7637-2		
Dimension(WxHxD)		200mm X 83mm X 330mm		
Weight		2.6 KG		
Cooling		Temperature & Load Controlled cooling Fan		
AC Transfer Function Accessories		TR-40 (optional)		

Table 2. SP-700 for Output 200/220/230/240 VAC Specification.



Note :

- ① Voltage range : Please refer to Figure 1
- ② Normal load Condition : $V_{in} = 12.5V/25V/50V$,
 $V_o = 200/220/230/240$ VAC 80% Full load (PF=1.0)
- ③ Operating temperature : Please refer to Figure 2

2-3-3. SP-1000 Specification

Electrical	Specification	Model No.		
	Item	SP-1000-112	SP-1000-124	SP-1000-148
Input Characteristics	Voltage	12VDC	24VDC	48VDC
	Input Over-Voltage Protection	16.5 ± 0.3VDC ^①	33 ± 0.5VDC ^①	66 ± 1.0VDC ^①
	Input Under-Voltage Protection	10.5 ± 0.3VDC	21 ± 0.5VDC	42 ± 1.0VDC
	Voltage Range	10.5~16.5 VDC	21~33 VDC	42~66 VDC
	No Load Current	<1.5 A @12VDC	<0.8 A @24VDC	<0.5 A @48VDC
	Power Saving Mode	<0.1A @12VDC	<0.06A @24VDC	<0.05A @48VDC
Output Characteristics	Continuous Output Power	1000 VA(± 3%)		
	Maximum output Power (1Min)	> 1000 VA~1150 VA (100%~115%)		
	Surge Power (1Sec)	< 1750 VA		
	Frequency	50 / 60 Hz ± 0.5% (Dip Switch Selectable)		
	Output Voltage	100 / 110 / 115 / 120 VAC (± 5%) (Dip Switch Selectable)		
	Efficiency max.	88%	89%	90%
	Short-Circuit Protection	1 Sec Shutdown		
	Output Waveform	Pure Sine Wave (THD < 5% @ Normal Load) ^②		
Signal and Control	Remote Controller Panel Unit	CR-8 / CR-16 (optional)		
	LED Indicator	Red / Orange / Green LED		
	Dry Contact Terminal	By a relay		
	Remote Control Terminal	6-port Green terminal (for inverter ON / OFF)		
Protection	Input Protection	Over / Under Voltage, Reverse Polarity (Internal Fuse)		
	AC Output Protection	Short-Circuit, Overload		
	Others	Over / Under Temperature Protection (by Heat sink Temperature +80°C/-20°C)		
Environment	Operating Temp.	-20 °C ~40 °C ^③		
	Storage Temp.	-30 °C ~70 °C		
	Storage Temp. & Humidity	10 ~95% RH		
Safety & EMC	Safety Standards	Certified UL 458 (UL only for GFCI receptacles)		----
	EMC standards	Certified FCC class B		
	E-mark	----		

Electrical	Specification	Model No.		
	Item	SP-1000-112	SP-1000-124	SP-1000-148
Dimension(WxHxD)		200mm X 83mm X 372mm		
Weight		3.26 KG		
Cooling		Temperature & Load Controlled cooling Fan		
AC Transfer Function Accessories		TR-40 (optional)		

Table 3. SP-1000 for Output 100/110/115/120 VAC Specification.



Note :

- ① Voltage range : Please refer to Figure 1
- ② Normal load Condition : $V_{in} = 12.5V/25V/50V$,
 $V_o = 100/110/115/120 \text{ VAC}$ 80% Full load (PF=1.0)
- ③ Operating temperature : Please refer to Figure 2

2-3-4. SP-1000 Specification

Electrical	Specification	Model No.		
	Item	SP-1000-212	SP-1000-224	SP-1000-248
Input Characteristics	Voltage	12VDC	24VDC	48VDC
	Input Over-Voltage Protection	$16.5 \pm 0.3\text{VDC}^{\text{①}}$	$33 \pm 0.5\text{VDC}^{\text{①}}$	$66 \pm 1.0\text{VDC}^{\text{①}}$
	Input Under-Voltage Protection	$10.5 \pm 0.3\text{VDC}$	$21 \pm 0.5\text{VDC}$	$42 \pm 1.0\text{VDC}$
	Voltage Range	10.5~16.5 VDC	21~33 VDC	42~66 VDC
	No Load Current	<1.5 A @12VDC	<0.8 A @24VDC	<0.4 A @48VDC
	Power Saving Mode	< 0.1A @12VDC	<0.05A @24VDC	<0.05A @48VDC
Output Characteristics	Continuous Output Power	1000 VA($\pm 3\%$)		
	Maximum output Power (1Min)	> 1000 VA~1150 VA (100%~115%)		
	Surge Power (1Sec)	< 1750 VA		
	Frequency	50 / 60 Hz $\pm 0.5\%$ (Dip Switch Selectable)		
	Output Voltage	200 / 220 / 230 / 240 VAC ($\pm 3\%$) (Dip Switch Selectable)		
	Efficiency max.	88%	89%	90%
	Short-Circuit Protection	1 Sec Shutdown		
	Output Waveform	Pure Sine Wave (THD < 5% @ Normal Load) ^②		

Electrical	Specification	Model No.		
	Item	SP-1000-212	SP-1000-224	SP-1000-248
Signal and Control	Remote Controller Panel Unit	CR-8 / CR-16 (optional)		
	LED Indicator	Red / Orange / Green LED		
	Dry Contact Terminal	By a relay		
	Remote Control Terminal	6-port Green terminal (for inverter ON / OFF)		
Protection	Input Protection	Over / Under Voltage, Reverse Polarity (Internal Fuse)		
	AC Output Protection	Short-Circuit, Overload		
	Others	Over / Under Temperature Protection (by Heat sink Temperature +80°C/-20°C)		
Environment	Operating Temp.	-20 °C ~40 °C ^①		
	Storage Temp.	-30 °C ~70 °C		
	Storage Temp. & Humidity	10 ~95% RH		
Safety & EMC	Safety Standards	Certified EN 60950-1		
	EMC standards	Certified EN 55022; EN 55024; EN 61000-3-2, -3-3 EN 61000-4-2, 3, 4, 5, 6, 8, 11		
	E-mark	Certified CISPR 25; ISO 11452-2; ISO 7637-2		
Dimension(WxHxD)		200mm X 83mm X 372mm		
Weight		3.26 KG		
Cooling		Temperature & Load Controlled cooling Fan		
AC Transfer Function Accessories		TR-40 (optional)		

Table 4. SP-1000 for Output 200/220/230/240 VAC Specification.



Note :

- ① Voltage range : Please refer to Figure 1
- ② Normal load Condition : $V_{in} = 12.5V/25V/50V$,
 $V_o = 200/220/230/240 \text{ VAC}$ 80% Full load (PF=1.0)
- ③ Operating temperature : Please refer to Figure 2

2-3-5. SP-1500 Specification

Electrical	Specification	Model No.		
	Item	SP-1500-112	SP-1500-124	SP-1500-148
Input Characteristics	Voltage	12VDC	24VDC	48VDC
	Input Over-Voltage Protection	16.5 ± 0.3VDC ^①	33 ± 0.5VDC ^①	66 ± 1.0VDC ^①
	Input Under-Voltage Protection	10.5 ± 0.3VDC	21 ± 0.5VDC	42 ± 1.0VDC
	Voltage Range	10.5~16.5 VDC	21~33 VDC	42~66 VDC
	No Load Current	<1.8A @12VDC	<0.9 A @24VDC	<0.5 A @48VDC
	Power Saving Mode	<0.1A @12VDC	<0.05A @24VDC	<0.05A @48VDC
Output Characteristics	Continuous Output Power	1500 VA(± 3%)		
	Maximum output Power (1Min)	> 1500 VA~1730VA (100%~115%)		
	Surge Power (1Sec)	<2650 VA		
	Frequency	50 / 60 Hz ± 0.5% (Dip Switch Selectable)		
	Output Voltage	100 / 110 / 115 / 120 VAC (± 5%) (Dip Switch Selectable)		
	Efficiency max.	88%	89%	90%
	Short-Circuit Protection	1 Sec Shutdown		
	Output Waveform	Pure Sine Wave (THD < 5% @ Normal Load) ^②		
Signal and Control	Remote Controller Panel Unit	CR-8 / CR-16 (optional)		
	LED Indicator	Red / Orange / Green LED		
	Dry Contact Terminal	By a relay		
	Remote Control Terminal	6-port Green terminal (for inverter ON / OFF)		
Protection	Input Protection	Over / Under Voltage, Reverse Polarity (Internal Fuse)		
	AC Output Protection	Short-Circuit, Overload		
	Others	Over / Under Temperature Protection (by Heat sink Temperature +80°C/-20°C)		
Environment	Operating Temp.	-20 °C ~40 °C ^③		
	Storage Temp.	-30 °C ~70 °C		
	Storage Temp. & Humidity	10 ~95% RH		

Electrical	Specification	Model No.		
	Item	SP-1500-112	SP-1500-124	SP-1500-148
Safety & EMC	Safety Standards	Certified UL 458 (UL only for GFCI receptacles)		----
	EMC standards	Certified FCC class B		
	E-mark	----		
Dimension(WxHxD)		248mm X 83mm X 421mm		
Weight		4.14 KG		
Cooling		Temperature & Load Controlled cooling Fan		
AC Transfer Function Accessories		TR-40 (optional)		

Table 5. SP-1500 for Output 100/110/115/120 VAC Specification.



Note :

- ① Voltage range : Please refer to Figure 1
- ② Normal load Condition : $V_{in} = 12.5V/25V/50V$,
 $V_o = 100/110/115/120VAC$ 80% Full load (PF=1.0)
- ③ Operating temperature : Please refer to Figure 2

2-3-6. SP-1500 Specification

Electrical	Specification	Model No.		
	Item	SP-1500-212	SP-1500-224	SP-1500-248
Input Characteristics	Voltage	12VDC	24VDC	48VDC
	Input Over-Voltage Protection	$16.5 \pm 0.3VDC$	$33 \pm 0.5VDC$	$66 \pm 1.0VDC$
	Input Under-Voltage Protection	$10.5 \pm 0.3VDC$ ①	$21 \pm 0.5VDC$ ①	$42 \pm 1.0VDC$ ①
	Voltage Range	10.5~16.5 VDC	21~33 VDC	42~66 VDC
	No Load Current	<1.8A @12VDC	<0.9 A @24VDC	<0.5 A @48VDC
	Power Saving Mode	<0.1A @12VDC	<0.05A @24VDC	<0.05A @48VDC
Output Characteristics	Continuous Output Power	1500 VA(± 3%)		
	Maximum output Power (1Min)	> 1500 VA~1730VA (100%~115%)		
	Surge Power (1Sec)	<2650 VA		
	Frequency	50 / 60 Hz ± 0.5% (Dip Switch Selectable)		
	Output Voltage	200 / 220 / 230 / 240 VAC (± 3%) (Dip Switch Selectable)		

Electrical	Specification	Model No.		
	Item	SP-1500-212	SP-1500-224	SP-1500-248
Output Characteristics	Efficiency max.	88%	89%	90%
	Short-Circuit Protection	1 Sec Shutdown		
	Output Waveform	Pure Sine Wave (THD < 5% @ Normal Load) [®]		
Signal and Control	Remote Controller Panel Unit	CR-8 / CR-16 (optional)		
	LED Indicator	Red / Orange / Green LED		
	Dry Contact Terminal	By a relay		
	Remote Control Terminal	6-port Green terminal (for inverter ON / OFF)		
Protection	Input Protection	Over / Under Voltage, Reverse Polarity (Internal Fuse)		
	AC Output Protection	Short-Circuit, Overload		
	Others	Over / Under Temperature Protection (by Heat sink Temperature +80°C/-20°C)		
Environment	Operating Temp.	-20 °C ~40 °C [®]		
	Storage Temp.	-30 °C ~70 °C		
	Storage Temp. & Humidity	10 ~95% RH		
Safety & EMC	Safety Standards	Certified EN 60950-1		
	EMC standards	Certified EN 55022; EN 55024; EN 61000-3-2, -3-3 EN 61000-4-2, 3, 4, 5, 6, 8, 11		
	E-mark	Certified CISPR 25; ISO 11452-2; ISO 7637-2		
Dimension(WxHxD)		248mm X 83mm X 421mm		
Weight		4.14 KG		
Cooling		Temperature & Load Controlled cooling Fan		
AC Transfer Function Accessories		TR-40 (optional)		

Table 6. SP-1500 for Output 200/220/230/240 VAC Specification.



Note :

- ① Voltage range : Please refer to Figure 1
- ② Normal load Condition : $V_{in} = 12.5V/25V/50V$,
 $V_o = 200/220/230/240$ VAC 80% Full load (PF=1.0)
- ③ Operating temperature : Please refer to Figure 2

2-3-7. SP-2000 Specification

Electrical	Specification	Model No.		
	Item	SP-2000-112	SP-2000-124	SP-2000-148
Input Characteristics	Voltage	12VDC	24VDC	48VDC
	Input Over-Voltage Protection	16.5 ± 0.3VDC [Ⓞ]	33 ± 0.5VDC [Ⓞ]	66 ± 1.0VDC [Ⓞ]
	Input Under-Voltage Protection	10.5 ± 0.3VDC	21 ± 0.5VDC	42 ± 1.0VDC
	Voltage Range	10.5~16.5 VDC	21~33 VDC	42~66 VDC
	No Load Current	<1.8 A @12VDC	<0.9 A @24VDC	<0.5 A @48VDC
	Power Saving Mode	<0.1A @12VDC	<0.05A @24VDC	<0.05A @48VDC
Output Characteristics	Continuous Output Power	2000 VA(± 3%)		
	Maximum output Power (1Min)	> 2000 VA~2300 VA (100%~115%)		
	Surge Power (1Sec)	< 3500 VA		
	Frequency	50 / 60 Hz ± 0.5% (Dip Switch Selectable)		
	Output Voltage	100 / 110 / 115 / 120 VAC (± 5%) (Dip Switch Selectable)		
	Efficiency max.	88%	89%	90%
	Short-Circuit Protection	1 Sec Shutdown		
	Output Waveform	Pure Sine Wave (THD < 5% @ Normal Load) [Ⓞ]		
Signal and Control	Remote Controller Panel Unit	CR-8 / CR-16 (optional)		
	LED Indicator	Red / Orange / Green LED		
	Dry Contact Terminal	By a relay		
	Remote Control Terminal	6-port Green terminal (for inverter ON / OFF)		
Protection	Input Protection	Over / Under Voltage, Reverse Polarity (Internal Fuse)		
	AC Output Protection	Short-Circuit, Overload		
	Others	Over / Under Temperature Protection (by Heat sink Temperature +80°C/-20°C)		
Environment	Operating Temp.	-20 °C ~ -40 °C [Ⓞ]		
	Storage Temp.	-30 °C ~ -70 °C		
	Storage Temp. & Humidity	10 ~95% RH		

Electrical	Specification	Model No.		
	Item	SP-2000-112	SP-2000-124	SP-2000-148
Safety & EMC	Safety Standards	Certified UL 458 (UL only for GFCI receptacles)		----
	EMC standards	Certified FCC class B		
	E-mark	----		
Dimension(WxHxD)		248mm X 83mm X 443mm		
Weight		5.24 KG		
Cooling		Temperature & Load Controlled cooling Fan		
AC Transfer Function Accessories		TR-40 (optional)		

Table 7. SP-2000 for Output 100/110/115/120 VAC Specification.



Note :

- ① Voltage range : Please refer to Figure 1
- ② Normal load Condition : $V_{in} = 12.5V/25V/50V$,
 $V_o = 100/110/115/120 \text{ VAC}$ 80% Full load (PF=1.0)
- ③ Operating temperature : Please refer to Figure 2

2-3-8. SP-2000 Specification

Electrical	Specification	Model No.		
	Item	SP-2000-212	SP-2000-224	SP-2000-248
Input Characteristics	Voltage	12VDC	24VDC	48VDC
	Input Over-Voltage Protection	$16.5 \pm 0.3\text{VDC}^{\text{①}}$	$33 \pm 0.5\text{VDC}^{\text{①}}$	$66 \pm 1.0\text{VDC}^{\text{①}}$
	Input Under-Voltage Protection	$10.5 \pm 0.3\text{VDC}$	$21 \pm 0.5\text{VDC}$	$42 \pm 1.0\text{VDC}$
	Voltage Range	10.5~16.5 VDC	21~33 VDC	42~66 VDC
	No Load Current	<1.8 A @12VDC	<0.9 A @24VDC	<0.5 A @48VDC
	Power Saving Mode	<0.1A @12VDC	<0.05A @24VDC	<0.05A @48VDC
Output Characteristics	Continuous Output Power	2000 VA($\pm 3\%$)		
	Maximum output Power (1Min)	> 2000 VA~2300 VA (100%~115%)		
	Surge Power (1Sec)	< 3500 VA		
	Frequency	50 / 60 Hz $\pm 0.5\%$ (Dip Switch Selectable)		
	Output Voltage	200 / 220 / 230 / 240 VAC ($\pm 3\%$) (Dip Switch Selectable)		
	Efficiency max.	89%	89%	90%

Electrical	Specification	Model No.		
	Item	SP-2000-212	SP-2000-224	SP-2000-248
Output Characteristics	Short-Circuit Protection	1 Sec Shutdown		
	Output Waveform	Pure Sine Wave (THD < 5% @ Normal Load) [®]		
Signal and Control	Remote Controller Panel Unit	CR-8 / CR-16 (optional)		
	LED Indicator	Red / Orange / Green LED		
	Dry Contact Terminal	By a relay		
	Remote Control Terminal	6-port Green terminal (for inverter ON / OFF)		
Protection	Input Protection	Over / Under Voltage, Reverse Polarity (Internal Fuse)		
	AC Output Protection	Short-Circuit, Overload		
	Others	Over / Under Temperature Protection (by Heat sink Temperature +80°C/-20°C)		
Environment	Operating Temp.	-20 °C ~ 40 °C [®]		
	Storage Temp.	-30 °C ~ 70 °C		
	Storage Temp. & Humidity	10 ~ 95% RH		
Safety & EMC	Safety Standards	Certified EN 60950-1		
	EMC standards	Certified EN 55022; EN 55024; EN 61000-3-2, -3-3 EN 61000-4-2, 3, 4, 5, 6, 8, 11		
	E-mark	Certified CISPR 25; ISO 11452-2; ISO 7637-2		
Dimension (WxHxD)		248mm X 83mm X 443mm		
Weight		5.24 KG		
Cooling		Temperature & Load Controlled cooling Fan		
AC Transfer Function Accessories		TR-40 (optional)		

Table 8. SP-2000 for Output 200/220/230/240 VAC Specification.



Note :

- ① Voltage range : Please refer to Figure 1
- ② Normal load Condition : $V_{in} = 12.5V/25V/50V$,
 $V_o = 200/220/230/240$ VAC 80% Full load (PF=1.0)
- ③ Operating temperature : Please refer to Figure 2

2-3-9. SP-3000 Specification

Electrical	Specification	Model No.		
	Item	SP-3000-112	SP-3000-124	SP-3000-148
Input Characteristics	Voltage	12VDC	24VDC	48VDC
	Input Over-Voltage Protection	16.5 ± 0.3VDC [Ⓞ]	33 ± 0.5VDC [Ⓞ]	66 ± 1.0VDC [Ⓞ]
	Input Under-Voltage Protection	10.5 ± 0.3VDC	21 ± 0.5VDC	42 ± 1.0VDC
	Voltage Range	10.5~16.5 VDC	21~33 VDC	42~66 VDC
	No Load Current	<3.8 A @12VDC	<1.9 A @24VDC	<1.0 A @48VDC
	Power Saving Mode	<0.4A @12VDC	<0.2A @24VDC	<0.1A @48VDC
Output Characteristics	Continuous Output Power	3000 VA(± 3%)		
	Maximum output Power (1Min)	> 3000 VA~3450 VA (100%~115%)		
	Surge Power (1Sec)	< 6000 VA		
	Frequency	50 / 60 Hz ± 0.5% (Dip Switch Selectable)		
	Output Voltage	100 / 110 / 115 / 120 VAC (± 5%) (Dip Switch Selectable)		
	Efficiency max.	88%	89%	90%
	Short-Circuit Protection	1 Sec Shutdown		
	Output Waveform	Pure Sine Wave (THD < 5% @ Normal Load) [Ⓞ]		
Signal and Control	Remote Controller Panel Unit	CR-8 / CR-16 (optional)		
	LED Indicator	Red / Orange / Green LED		
	Dry Contact Terminal	By a relay		
	Remote Control Terminal	6-port Green terminal (for inverter ON / OFF)		
Protection	Input Protection	Over / Under Voltage, Reverse Polarity (Internal Fuse)		
	AC Output Protection	Short-Circuit, Overload		
	Others	Over / Under Temperature Protection (by Heat sink Temperature +80°C/-20°C)		
Environment	Operating Temp.	-20 °C ~ -40 °C [Ⓞ]		
	Storage Temp.	-30 °C ~ -70 °C		
	Storage Temp. & Humidity	10 ~95% RH		

Electrical	Specification	Model No.		
	Item	SP-3000-112	SP-3000-124	SP-3000-148
Safety & EMC	Safety Standards	Certified UL 458		----
	EMC standards	Certified FCC class A		
	E-mark	----		
Dimension(WxHxD)		255mm X 158mm X 442mm		
Weight		8.2 KG		
Cooling		Temperature & Load Controlled cooling Fan		
AC Transfer Function Accessories		TR-40 (optional)		

Table 9. SP-3000 for Output 100/110/115/120 VAC Specification.



Note :

- ① Voltage range : Please refer to Figure 1
- ② Normal load Condition : $V_{in} = 12.5V/25V/50V$,
 $V_o = 100/110/115/120 \text{ VAC}$ 80% Full load (PF=1.0)
- ③ Operating temperature : Please refer to Figure 2

2-3-10. SP-3000 Specification

Electrical	Specification	Model No.		
	Item	SP-3000-212	SP-3000-224	SP-3000-248
Input Characteristics	Voltage	12VDC	24VDC	48VDC
	Input Over-Voltage Protection	$16.5 \pm 0.3VDC^{\circ}$	$33 \pm 0.5VDC^{\circ}$	$66 \pm 1.0VDC^{\circ}$
	Input Under-Voltage Protection	$10.5 \pm 0.3VDC$	$21 \pm 0.5VDC$	$42 \pm 1.0VDC$
	Voltage Range	10.5~16.5 VDC	21~33 VDC	42~66 VDC
	No Load Current	<3.8 A @12VDC	<1.9 A @24VDC	<1.0 A @48VDC
	Power Saving Mode	<0.4A @12VDC	<0.2A @24VDC	<0.1A @48VDC
Output Characteristics	Continuous Output Power	3000 VA($\pm 3\%$)		
	Maximum output Power (1Min)	> 3000 VA~3450 VA (100%~115%)		
	Surge Power (1Sec)	< 6000 VA		
	Frequency	50 / 60 Hz $\pm 0.5\%$ (Dip Switch Selectable)		
	Output Voltage	200 / 220 / 230 / 240 VAC ($\pm 3\%$) (Dip Switch Selectable)		

Electrical	Specification	Model No.		
	Item	SP-3000-212	SP-3000-224	SP-3000-248
Output Characteristics	Efficiency max.	89%	89%	90%
	Short-Circuit Protection	1 Sec Shutdown		
	Output Waveform	Pure Sine Wave (THD < 5% @ Normal Load) [®]		
Signal and Control	Remote Controller Panel Unit	CR-8 / CR-16 (optional)		
	LED Indicator	Red / Orange / Green LED		
	Dry Contact Terminal	By a relay		
	Remote Control Terminal	6-port Green terminal (for inverter ON / OFF)		
Protection	Input Protection	Over / Under Voltage, Reverse Polarity (Internal Fuse)		
	AC Output Protection	Short-Circuit, Overload		
	Others	Over / Under Temperature Protection (by Heat sink Temperature +80°C/-20°C)		
Environment	Operating Temp.	-20 °C ~ 40 °C [®]		
	Storage Temp.	-30 °C ~ 70 °C		
	Storage Temp. & Humidity	10 ~95% RH		
Safety & EMC	Safety Standards	Certified EN 60950-1		
	EMC standards	Certified EN 55022; EN 55024; EN 61000-3-2, -3-3 EN 61000-4-2, 3, 4, 5, 6, 8, 11		
	E-mark	Certified CISPR 25; ISO 11452-2; ISO 7637-2		
Dimension(WxHxD)		255mm X 158mm X 442mm		
Weight		8.2 KG		
Cooling		Temperature & Load Controlled cooling Fan		
AC Transfer Function Accessories		TR-40 (optional)		

Table 10. SP-3000 for Output 200/220/230/240 VAC Specification.



Note :

- ① Voltage range : Please refer to Figure 1
- ② Normal load Condition : $V_{in} = 12.5V/25V/50V$,
 $V_o = 200/220/230/240 \text{ VAC}$ 80% Full load (PF=1.0)
- ③ Operating temperature : Please refer to Figure 2

2-3-11. SP-4000 Specification

Electrical	Specification	Model No.	
	Item	SP-4000-124	SP-4000-148
Input Characteristics	Voltage	24VDC	48VDC
	Input Over-Voltage Protection	33 ± 0.5VDC [Ⓟ]	66 ± 1.0VDC [Ⓟ]
	Input Under-Voltage Protection	21 ± 0.5VDC	42 ± 1.0VDC
	Voltage Range	21~33 VDC	42~66 VDC
	No Load Current	<1.9 A @24VDC	<1.0 A @48VDC
	Power Saving Mode	<0.2A @24VDC	<0.1A @48VDC
Output Characteristics	Continuous Output Power	4000 VA(± 3%)	
	Maximum output Power (1Min)	> 4000 VA~4600 VA (100%~115%)	
	Surge Power (1Sec)	< 8000 VA	
	Frequency	50 / 60 Hz ± 0.5% (Dip Switch Selectable)	
	Output Voltage	100 / 110 / 115 / 120 VAC (± 5%) (Dip Switch Selectable)	
	Efficiency max.	88%	90%
	Short-Circuit Protection	1 Sec Shutdown	
	Output Waveform	Pure Sine Wave (THD < 5% @ Normal Load) [Ⓟ]	
Signal and Control	Remote Controller Panel Unit	CR-8 / CR-16 (optional)	
	LED Indicator	Red / Orange / Green LED	
	Dry Contact Terminal	By a relay	
	Remote Control Terminal	6-port Green terminal (for inverter ON / OFF)	
Protection	Input Protection	Over / Under Voltage, Reverse Polarity (Internal Fuse)	
	AC Output Protection	Short-Circuit, Overload	
	Others	Over / Under Temperature Protection (by Heat sink Temperature +80°C/-20°C)	
Environment	Operating Temp.	-20 °C ~40 °C [Ⓟ]	
	Storage Temp.	-30 °C ~70 °C	
	Storage Temp. & Humidity	10 ~95% RH	
Safety & EMC	Safety Standards	Certified UL 458 (Only for 115/120VAC)	----
	EMC standards	Certified FCC class A	
	E-mark	----	

Electrical	Specification	Model No.	
	Item	SP-4000-124	SP-4000-148
	Dimension(WxHxD)	255mm X 158mm X 462mm	
	Weight	10 KG	
	Cooling	Temperature & Load Controlled cooling Fan	
	AC Transfer Function Accessories	TR-40 (optional)	

Table 11. SP-4000 for Output 100/110/115/120 VAC Specification.



Note :

- ① Voltage range : Please refer to Figure 1
- ② Normal load Condition : $V_{in} = 25V/50V$,
 $V_o = 100/110/115/120$ VAC 80% Full load (PF=1.0)
- ③ Operating temperature : Please refer to Figure 2

2-3-12. SP-4000 Specification

Electrical	Specification	Model No.	
	Item	SP-4000-224	SP-4000-248
Input Characteristics	Voltage	24VDC	48VDC
	Input Over-Voltage Protection	$33 \pm 0.5VDC^{\circ}$	$66 \pm 1.0VDC^{\circ}$
	Input Under-Voltage Protection	$21 \pm 0.5VDC$	$42 \pm 1.0VDC$
	Voltage Range	21~33 VDC	42~66 VDC
	No Load Current	<1.9 A @24VDC	<1.0 A @48VDC
	Power Saving Mode	<0.2A @24VDC	<0.1A @48VDC
Output Characteristics	Continuous Output Power	4000 VA($\pm 3\%$)	
	Maximum output Power (1Min)	> 4000 VA~4600 VA (100%~115%)	
	Surge Power (1Sec)	< 8000 VA	
	Frequency	50 / 60 Hz $\pm 0.5\%$ (Dip Switch Selectable)	
	Output Voltage	200 / 220 / 230 / 240 VAC ($\pm 3\%$) (Dip Switch Selectable)	
	Efficiency max.	88%	90%
	Short-Circuit Protection	1 Sec Shutdown	
Output Waveform	Pure Sine Wave (THD < 5% @ Normal Load) [®]		
Signal and Control	Remote Controller Panel Unit	CR-8 / CR-16 (optional)	
	LED Indicator	Red / Orange / Green LED	

Electrical	Specification	Model No.	
	Item	SP-4000-224	SP-4000-248
Signal and Control	Dry Contact Terminal	By a relay	
	Remote Control Terminal	6-port Green terminal (for inverter ON / OFF)	
Protection	Input Protection	Over / Under Voltage, Reverse Polarity (Internal Fuse)	
	AC Output Protection	Short-Circuit, Overload	
	Others	Over / Under Temperature Protection (by Heat sink Temperature +80°C/-20°C)	
Environment	Operating Temp.	-20 °C ~40 °C ^③	
	Storage Temp.	-30 °C ~70 °C	
	Storage Temp. & Humidity	10 ~95% RH	
Safety & EMC	Safety Standards	Certified EN 60950-1	
	EMC standards	Certified EN 55022; EN 55024; EN 61000-3-2, -3-3; EN 61000-4-2, 3, 4, 5, 6, 8, 11	
	E-mark	Certified CISPR 25; ISO 11452-2; ISO 7637-2	
Dimension(WxHxD)		255mm X 158mm X 462mm	
Weight		10 KG	
Cooling		Temperature & Load Controlled cooling Fan	
AC Transfer Function Accessories		TR-40 (optional)	

Table 12. SP-4000 for Output 100/110/115/120 VAC Specification.



Note :

- ① Voltage range : Please refer to Figure 1
- ② Normal load Condition : $V_{in} = 25V/50V$,
 $V_o = 200/220/230/240$ VAC 80% Full load (PF=1.0)
- ③ Operating temperature : Please refer to Figure 2

2-3-13. Voltage & temperature performance

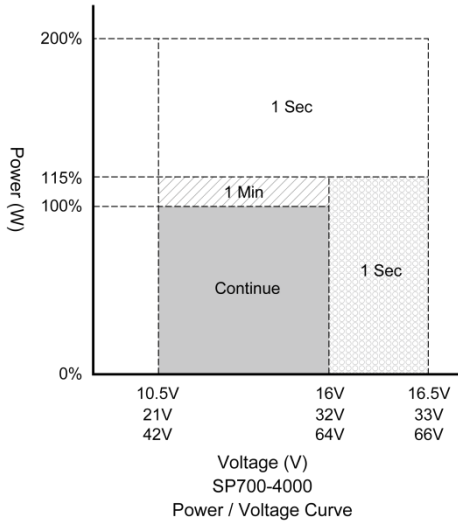

Figure 1. Output power vs. input voltage

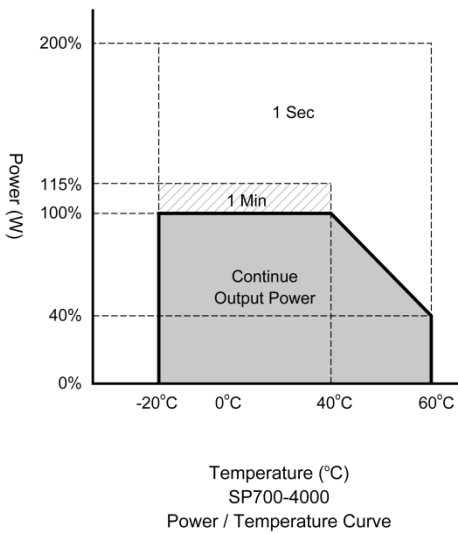

Figure 2. Output power vs. temperature

2-4. Mechanical Drawings

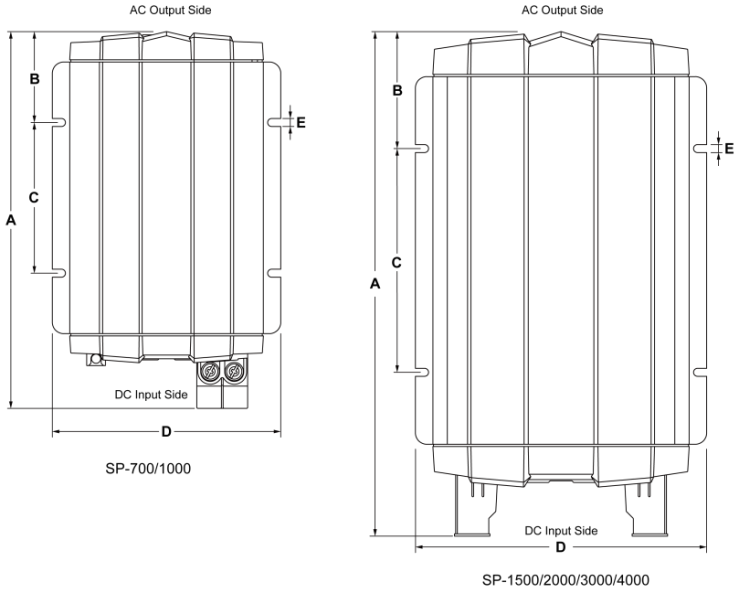

Figure 3. SP series drawing (Top View)

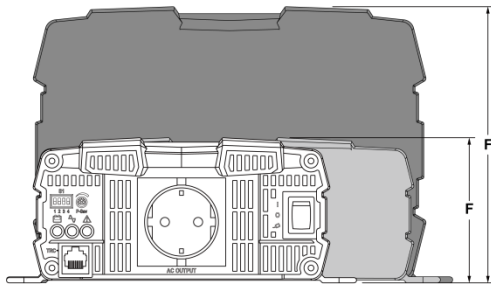

Figure 4. SP series drawing (AC output/Front View)

Model	A (mm)	B (mm)	C (mm)	D (mm)	E (mm)	F (mm)
SP-700	330	80	132	200	7.0	83
SP-1000	372	69	196	200	7.0	83
SP-1500	421	92	196	248	7.0	83
SP-2000	443	103	196	248	7.0	83
SP-3000	442	103	196	255	7.0	158
SP-4000	462	113	196	255	7.0	158

Table 13. SP Series Dimension

3. Installation and Maintenance

3-1. AC Output Side (Front Panel) Introduction

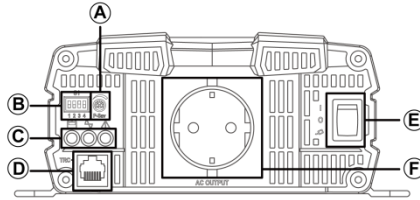

Figure 5. SP-700/1000 AC output panel view

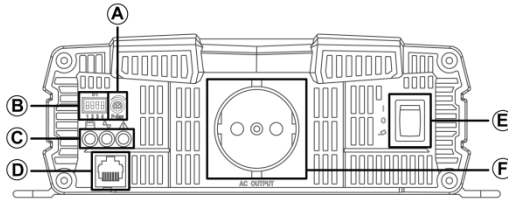

Figure 6. SP-1500/2000 AC output panel view

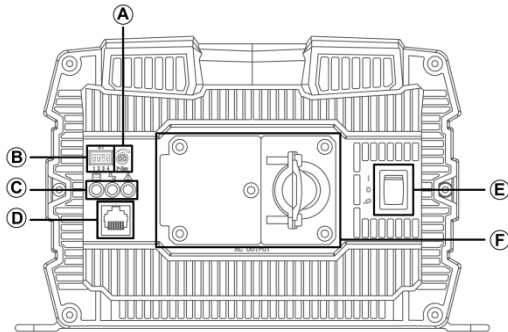

Figure 7. SP-3000/4000 AC output panel view

Model	SP-700	SP-1000	SP-1500	SP-2000	SP-3000	SP-4000
Ⓐ	Saving power adjustment					
Ⓑ	Function switch					
Ⓒ	Function LED					
Ⓓ	TRC port (RJ45)					
Ⓔ	Main switch					
Ⓕ	AC output socket				AC output terminal	

Table 14. SP Series AC output side introduction

3-1-1. Main Switch

The 3-stage switch (E) is for turning on, turning off and remote mode.

3-1-2. LED Indicator

3-1-2-1. Input voltage level: to display Input Voltages

LED status (C)	DC 12V	DC 24V	DC 48V
Red	< 11.0V	< 22.0V	< 44.0V
Orange	11.0 ~ 11.5V	22.0 ~ 23.0V	44.0~46.0V
Green	11.5 ~ 15.0V	23.0 ~ 30.0V	46.0~60.0V
Orange	15.0 ~ 15.5V	30.0 ~ 31.0V	60.0~62.0V
Red	>15.5V	>31.0V	>62.0V

Table 15. Input Voltage Level LED Indicator

3-1-2-2. Output Load Level to display AC Loads (PF=1)

LED status (C)	Green	Orange	Red
SP-700	0 ~ 700 VA	700 ~ 805 VA	> 805 VA
SP-1000	0 ~ 1000 VA	1000 ~ 1150 VA	> 1150 VA
SP-1500	0 ~ 1500 VA	1500 ~ 1725 VA	> 1725 VA
SP-2000	0 ~ 2000 VA	2000 ~ 2300 VA	> 2300 VA
SP-3000	0 ~ 3000 VA	3000 ~ 3450 VA	> 3450 VA
SP-4000	0 ~ 4000 VA	4000 ~ 4600 VA	> 4600 VA

Table 16. Output Load Level LED Indicator

3-1-2-3. Inverter Status to display Fault condition

LED status (C)	Status	Recovery point
Green	Normal	
Red	Over Current Protection / Over Load Protection (AC output short and over load)	
Red Blink	Under Voltage Protection (Input DC voltage under spec)	12.5V @ DC12V system 25V @ DC24V system 50V @ DC48V system
Red Fast Blink	Over Voltage Protection (Input DC voltage over spec)	14.5V @ DC12V system 29V @ DC24V system 58V @ DC48V system

LED status (C)	Status	Recovery point
Orange	Device startup process abnormal	—
Orange Fast Blink	Under Temperature Protection (Heat sink temp. under -20 degree)	> 0 degree C
Orange Slow Blink	Over Temperature Protection (Heat sink temp. over 80 degree)	< 60 degree C (heat sink temperature)

Table 17. Inverter LED Status Indicator

3-1-3. Function Switch Introduction

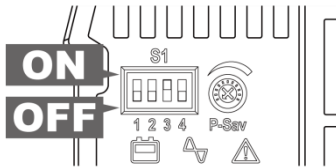

Figure 8. DIP switch ON/OFF position

3-1-3-1. Function Switch Definition

Dip Switch (B)	Function
S1	Voltage select
S2	Voltage select
S3	Frequency Select
S4	Power saving ON/OFF

Table 18. Function Switch Definition

3-1-3-2. Output voltage selection (S1&S2)

Output voltage	S1	S2
100V/200V	OFF	OFF
110V/220V	ON	OFF
115V/230V	OFF	ON
120V/240V	ON	ON

Table 19. Function Switch definition: output voltage selection



Note! 100V series can be selected between 100/110/115/120VAC, and 200V series can be selected between 200/220/230/240VAC.

3-1-3-3. Output Frequency Selection (S3)

Frequency	S3
50Hz	OFF
60Hz	ON

Table 20. Function Switch definition: Output Frequency selection

3-1-3-4. Power Saving Selection (S4)

Saving function	S4
Power Saving OFF	OFF
Power Saving ON	ON

Table 21. Function Switch definition: Power Saving selection

3-1-3-5. Power Saving Load Adjustment

User can use variable resistor (VR) to set the input and wake up power saving threshold according to the load condition, and the setting range shows below:

Ⓐ	Input Saving Power (Min)	Saving Wake up Power (Min)
SP-700	<20 VA	>40 VA
SP-1000	<20 VA	>40 VA
SP-1500	<20 VA	>40 VA
SP-2000	<20 VA	>40 VA
SP-3000	<40 VA	>60 VA
SP-4000	<40 VA	>60 VA

Table 22. Power saving setting range (Min)

Ⓐ	Input Saving Power (Max)	Saving Wake up Power (Max)
SP-700	<110 VA	>160 VA
SP-1000	<110 VA	>160 VA
SP-1500	<110 VA	>160 VA
SP-2000	<110 VA	>160 VA
SP-3000	<240 VA	>280 VA
SP-4000	<240 VA	>280 VA

Table 23. Power saving setting range (Max)

3-1-4. TRC Port (for optional kits TR-40, RJ-45)

Pin Number	Signal Description Ⓓ	
1	Reserved	--
2	PH-L	Zero-Crossing Signal
3	PH-N	Zero-Crossing Signal

Pin Number	Signal Description (D)	
4	Bypass	Transfer Relay Driver Signal
5	12V	Internal power for TR40 controller
6	5V	Internal power for TR40 controller
7	GND	The same polarity as the battery negative side
8	Reserved	--

Table 24. SP Series TRC Port : RJ-45.

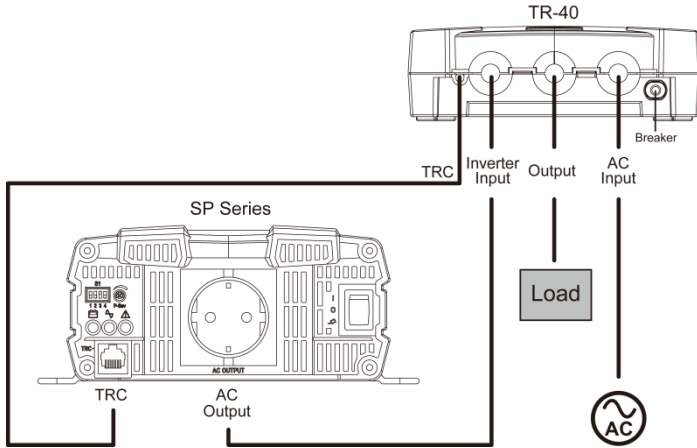

Figure 9. Wiring between SP series and TR-40



Note! The detail information please refer to TR-40 user manual

3-1-5. AC output Interface

3-1-5-1. SP-700/1000/1500/2000 AC output interface

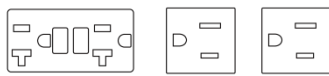
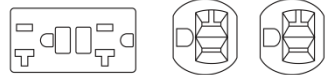
Socket Type (F)	Applicable Model
 <p>North America (GFCI) NEMA 5-15R</p>	SP-700/1000-112/124/148
 <p>North America (GFCI) NEMA 5-20R</p>	SP-1500/2000-112/124/148



Socket Type (F)	Applicable Model
 <p>Australia / New Zealand Continental European UK</p>	SP-700/1000/1500/2000/3000-212/224/248
 <p>Universal</p>	SP-700/1000/1500/2000-112/124/148 SP-700/1000/1500/2000/3000-212/224/248
 <p>Hard Wire</p>	SP-3000-112/124/148/212/224/248 SP-4000-124/148/224/248
 <p>France Connector</p>	SP-700/1000/1500/2000/3000-212/224/248

Table 25. SP Series AC Socket vs. Model

3-1-5-2. SP-3000/4000 AC output interface

Terminal (F)	Wire color	Wire length / gauge
AC terminal	Line (L)	Black
	Neutral (N)	White
FG (Ground)	Green / Yellow or Bare copper	200-240VAC: AWG# 10 100-120VAC: AWG# 8 26~32 feet / AWG# 10 ~ 8

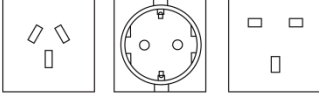
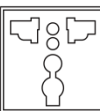
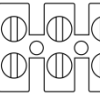
Table 26. SP-3000/4000 Series AC output wiring

3-1-5-3. GFCI connector

Recommend GFCI connector :

- HUBBELL INC WIRING DEVICE DIV, Type GF20. Rated 125V, 20A
- COOPER WIRING DEVICES, Type VGF20. Rated 125V, 20A
- LEVITON MFG CO INC, Type 7899-W. Rated 125V, 20A

3-2. DC Input Side (Rear Panel) Introduction

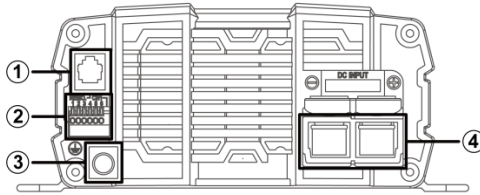

Figure 10. SP-700/1000

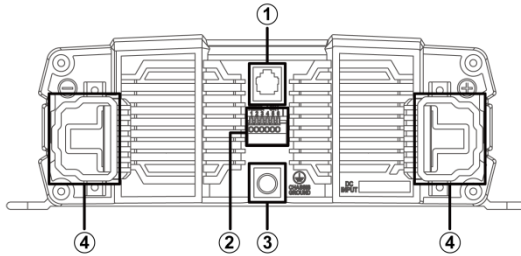

Figure 11. SP-1500/2000

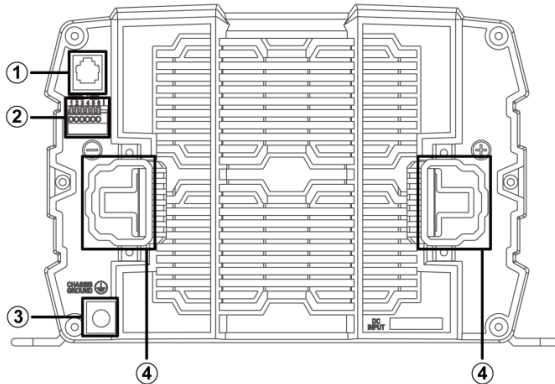

Figure 12. SP-3000/4000

Model	SP-700	SP-1000	SP-1500	SP-2000	SP-3000	SP-4000
①	Remote port (RJ11)					
②	Remote control green terminal					
③	Chassis ground					
④	DC input connector					

Table 27. Series DC input side introduction

3-2-1. Remote Port (RJ-11)

The SP Series Inverter can be compatible with CR-8, and CR-16 remote control via RS-232 Communication.

Before using the remote control, make sure the main switch on inverter must be at “REMOTE” position.

Pin Number	Signal Description ①	
1	Reserved	--
2	GND	The same polarity as the battery negative side
3	RXD	RS232 RXD
4	TXD	RS232 TXD
5	RMT	Remote controller panel (positive)
6	VCC	Internal power for remote controller

Table 28. SP Series Remote Port : RJ-11

3-2-2. Remote Control Green Terminal

Remote control green terminal ② may be connected to a Form C relay for “FAULT” indication. When “FAULT” occurs, the relay switches.

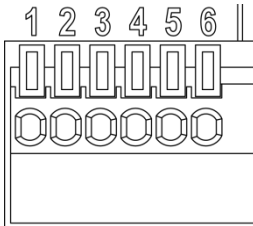

Figure 13. Remote control terminal

Item	Description	Item	Description
1	Dry contact (Normal Open)	4	Enable+ (ENB)
2	Common	5	Enable- (ENB)
3	Dry contact (Normal Closed)	6	Ground

Table 29. Dry contact terminal definition



Note! Pin-6 is the same polarity with battery negative electrode.



Note! Fault conditions include Input under / over voltage, output short circuit / over load, over / under temperature.



Caution! Please follow the following steps for the installation

- Before installing the inverter, make sure the main switch is at “OFF” position.
- Before using the remote function, make sure the main switch pressed toward “REMOTE”
- Use 20 ~ 24 #AWG wire to connect the remote control terminals

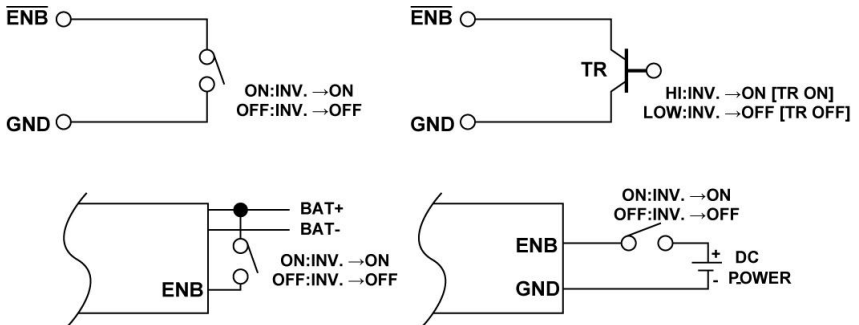

Figure 14. Wiring for control

3-2-3. General instruction before DC Input ④

3-2-3-1 Before installation:

The DC cables should be as short as possible (less than 6 feet / 1.8 meters ideally)

The size of the cable should be thick enough to limit the voltage drop to less than 2% when carrying the maximum input current to prevent frequent low-input voltage warnings, and shutdown.

The following sizes of cables and fuses are recommended for up to 6 ft. distance between the batteries and the inverter.

Model	Wire AWG	Inline fuse
SP-700-112 / 212	#6	≥ 150A
SP-700-124 / 224	#10	≥ 80 A
SP-700-148 / 248	#16	≥ 50 A
SP-1000-112 / 212	#4	≥ 225A
SP-1000-124 / 224	#8	≥ 125A
SP-1000-148 / 248	#14	≥ 80A
SP-1500-112 / 212	#1	≥ 350A
SP-1500-124 / 224	#6	≥ 175A
SP-1500-148 / 248	#10	≥ 90A
SP-2000-112 / 212	#1/0	≥ 500A
SP-2000-124 / 224	#4	≥ 225A
SP-2000-148 / 248	#8	≥ 150A
SP-3000-112 / 212	#4/0	≥ 700A
SP-3000-124 / 224	#1	≥ 350A
SP-3000-148 / 248	#6	≥ 175A
SP-4000-124 / 224	#1/0	≥ 500A
SP-4000-148 / 248	#4	≥ 275A

Table 30. SP Series Wiring Cable diameter and Inline Fuse



Note! Batteries are capable of providing very large currents in case of short circuit. The fuse should be as close to the positive battery terminal as possible. Use Bussmann ANN series fuses (will also require Fuse Block 4164) or equivalent.

3-2-4. Chassis Ground ③

Must be connected to earth ground prior to making any other connections to the equipment.

3-3. Maintenance

Make sure that the fan vents are not blocked.

Use a vacuum cleaner to remove any dust from the fan area. When cleaning the case or front panel, use a soft, dry cloth, only. If the case or front panel is very dirty, use a neutral, non-abrasive detergent. Do not use alcohol or ammonia based solutions.

Regular service, and relocation of the inverter, should be performed by a qualified service technician. Avoid spilling liquid on the inverter.

4. Operation

4-1. Connection the DC cable

Connect DC input terminals to 12V / 24V / 48V battery or other DC power source [+] is positive, [-] is negative. Reverse polarity connection can blow the internal fuse and may damage the inverter permanently.



Figure 15. DC cable connection



Warning! Make sure that all the DC connections are tight (torque to 9 – 10 ft-lbs, 11.7 – 13 Nm). Loose connections could result in overheating and can be a potential hazard.



Warning! The recommended inline fuse should be installed as close to the battery positive terminal as possible failure to use a fuse on the “+” cable running between the inverter and battery may cause damage to the cable / inverter and will void warranty.

Also, only use high quality copper wire and keep the cable length short which is a maximum of 3 - 6 feet.

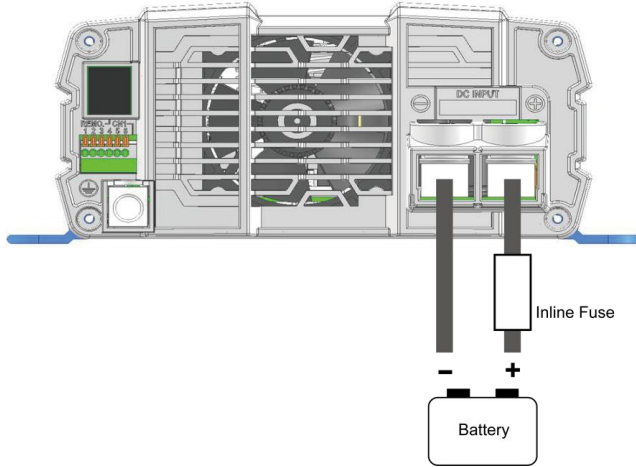

Figure 16. Battery cabling

4-2. Connecting the input power

Before making the DC input side connections ④, the main switch ⑤ must be at “OFF”.

4-3. Connecting the loads

Calculate the total power consumption of the output load. Make sure that the total power consumption does not exceed the rated power.

If the total power consumption over the rated power of the inverter, remove the non-critical loads until the total power consumption is below the rated power.

4-4. Switch ON Inverter

Set the power switch to the “ON” position ⑤. The inverter will carry out self-diagnosis and, the LED’s will also appear various colors. Set the power switch to the “OFF” position ⑤. The inverter stops and all the lights that are on will go off.

4-5. Protection Mechanism

Model	Over Voltage (DC)		Under Voltage Alarm	Under Voltage	
	Shutdown	Restart		Shutdown	Restart
12V	16.5V ± 0.3V	14.5V± 0.3V	11V ± 0.3V	10.5V ± 0.3V	12.5V± 0.3V
24V	33V ± 0.5V	29V ± 0.5V	22V± 0.3V	21V ± -0.5V	25V ± 0.5V
48V	66 ± 1V	58V ± 1V	44V± 0.3V	42V ± 1V	50 ± 1V

Table 31. Protection Mechanism

Model	Over temperature protection	
	Shutdown	Restart
12V	80	60
24V		
48V		

Table 32. Over Temperature Protection Mechanism

5. RS232 Communication and Operation

5-1. RS232 Port

RS232 Port : Serial port monitoring and control through computer interface.

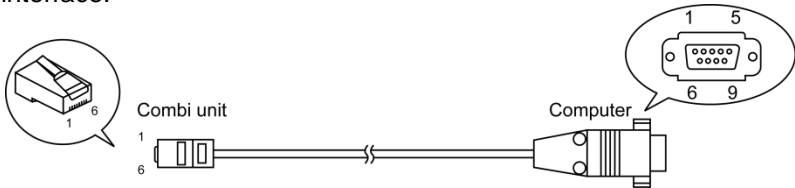

Figure 17. RS-232 cable

SP Series		Computer	
PIN Number	Description	PIN Number	Description
1	Not used	Not used	1
2	GND	RXD	2
3	RXD	TXD	3
4	TXD	Not used	4
5	Remo Control	GND	5
6	VCC	Not used	6

SP Series		Computer	
PIN Number	Description	PIN Number	Description
		Not used	7
		Not used	8
		Not used	9

Table 33. RS232 interface definition

5-2. RS232 Port Operating

The following steps show the connection among inverter and computer.

- Step 1 Connect the RS232 port to the SP series unit on the front panel
- Step 2 Run the computer communication program
- Step 3 Set the transmission protocol
Byte structure: START-BIP – 8 BIT DATA-STOP BIT
Baud rate: 4800
- Step 4 Select the COM port and start the operation

5-3. Example of RS232 Port Operating

5-3-1. RS232 command format

This unit uses high-level language commands starts with CR (0DH) and LF(0AH) as the end of the command, The system would interpret and execute the command only after these two characters are received. After the unit executes the command, it would send a response string to the computer

The response string is as follows:

- => CR LF: Command executed successfully
- ?> CR LF: Command error, not accepted
- !> CR LF: Command correct but execution error (e.g. parameters out of range)

5-3-2. Command format

The following table shows the useful command to operate SP series.

Function	Command and description																						
Turn ON / OFF SP series	Format : Power <value> <value> can be one of the following. "0" : Power OFF "1" : Power ON																						
Query the SP series output frequency	Format: FRQ?																						
Query the SP series output voltage	Format: VINV?																						
Query the SP series output current	Format: IINV?																						
Query the SP series status	Format: ERR? (SP-700~2000)																						
	<table border="1"> <thead> <tr> <th>Bit</th> <th>Description</th> </tr> </thead> <tbody> <tr> <td>BIT0</td> <td>0: No OLPL Protection 1: OLPL Protection</td> </tr> <tr> <td>BIT1</td> <td>0:No Sof Fail Protection 1:SofFail Protection</td> </tr> <tr> <td>BIT2</td> <td>0:No Poff Protection 1:Poff Protection</td> </tr> <tr> <td>BIT3</td> <td>0:No UVP Protection 1:UVP Protection</td> </tr> <tr> <td>BIT4</td> <td>0:NoOVP Protection 1:OVP Protection</td> </tr> <tr> <td>BIT5</td> <td>0:No OLPM Protection 1: OLPM Protection</td> </tr> <tr> <td>BIT6</td> <td>0:No OLPH Protection 1: OLPH Protection</td> </tr> <tr> <td>BIT7</td> <td>0:No OTP Protection 1: OTP Protection</td> </tr> <tr> <td>BIT8</td> <td>0:No UTP Protection 1: UTP Protection</td> </tr> <tr> <td>BIT9</td> <td>0:No OSCP Protection 1: OSCP Protection</td> </tr> </tbody> </table>	Bit	Description	BIT0	0: No OLPL Protection 1: OLPL Protection	BIT1	0:No Sof Fail Protection 1:SofFail Protection	BIT2	0:No Poff Protection 1:Poff Protection	BIT3	0:No UVP Protection 1:UVP Protection	BIT4	0:NoOVP Protection 1:OVP Protection	BIT5	0:No OLPM Protection 1: OLPM Protection	BIT6	0:No OLPH Protection 1: OLPH Protection	BIT7	0:No OTP Protection 1: OTP Protection	BIT8	0:No UTP Protection 1: UTP Protection	BIT9	0:No OSCP Protection 1: OSCP Protection
	Bit	Description																					
	BIT0	0: No OLPL Protection 1: OLPL Protection																					
	BIT1	0:No Sof Fail Protection 1:SofFail Protection																					
	BIT2	0:No Poff Protection 1:Poff Protection																					
	BIT3	0:No UVP Protection 1:UVP Protection																					
	BIT4	0:NoOVP Protection 1:OVP Protection																					
	BIT5	0:No OLPM Protection 1: OLPM Protection																					
	BIT6	0:No OLPH Protection 1: OLPH Protection																					
	BIT7	0:No OTP Protection 1: OTP Protection																					
	BIT8	0:No UTP Protection 1: UTP Protection																					
	BIT9	0:No OSCP Protection 1: OSCP Protection																					
	Format: ERR? (SP-3000~4000)																						
	<table border="1"> <thead> <tr> <th>Bit</th> <th>Description</th> </tr> </thead> <tbody> <tr> <td>BIT0</td> <td>0: No ID Fail 1: ID Fail</td> </tr> <tr> <td>BIT1</td> <td>0:No Sof Fail Protection 1:SofFail Protection</td> </tr> </tbody> </table>	Bit	Description	BIT0	0: No ID Fail 1: ID Fail	BIT1	0:No Sof Fail Protection 1:SofFail Protection																
	Bit	Description																					
	BIT0	0: No ID Fail 1: ID Fail																					
	BIT1	0:No Sof Fail Protection 1:SofFail Protection																					

Function	Command and description																				
	<table border="1"> <tr> <td>BIT2</td> <td>0:No PLL Fail 1:PLL Fail</td> </tr> <tr> <td>BIT3</td> <td>0:No Poff Protection 1:Poff Protection</td> </tr> <tr> <td>BIT4</td> <td>0:No Short Protection 1:Short Protection</td> </tr> <tr> <td>BIT5</td> <td>0:No OSCP Protection 1: OSCP Protection</td> </tr> <tr> <td>BIT6</td> <td>0:NoOVP Protection 1:OVP Protection</td> </tr> <tr> <td>BIT7</td> <td>0:No UVP Protection 1:UVP Protection</td> </tr> <tr> <td>BIT8</td> <td>0:No OTP Protection 1: OTP Protection</td> </tr> <tr> <td>BIT9</td> <td>0:No UTP Protection 1: UTP Protection</td> </tr> <tr> <td>BIT10</td> <td>0:No OLPL Protection 1: OLPL Protection</td> </tr> <tr> <td>BIT11</td> <td>0:No OLPH Protection 1: OLPH Protection</td> </tr> </table>	BIT2	0:No PLL Fail 1:PLL Fail	BIT3	0:No Poff Protection 1:Poff Protection	BIT4	0:No Short Protection 1:Short Protection	BIT5	0:No OSCP Protection 1: OSCP Protection	BIT6	0:NoOVP Protection 1:OVP Protection	BIT7	0:No UVP Protection 1:UVP Protection	BIT8	0:No OTP Protection 1: OTP Protection	BIT9	0:No UTP Protection 1: UTP Protection	BIT10	0:No OLPL Protection 1: OLPL Protection	BIT11	0:No OLPH Protection 1: OLPH Protection
BIT2	0:No PLL Fail 1:PLL Fail																				
BIT3	0:No Poff Protection 1:Poff Protection																				
BIT4	0:No Short Protection 1:Short Protection																				
BIT5	0:No OSCP Protection 1: OSCP Protection																				
BIT6	0:NoOVP Protection 1:OVP Protection																				
BIT7	0:No UVP Protection 1:UVP Protection																				
BIT8	0:No OTP Protection 1: OTP Protection																				
BIT9	0:No UTP Protection 1: UTP Protection																				
BIT10	0:No OLPL Protection 1: OLPL Protection																				
BIT11	0:No OLPH Protection 1: OLPH Protection																				
Query the SP series DC input voltage of the battery	Format: VBAT?																				
Query the SP series output power	Format: PINV?																				
Reset default	Format:*RST																				
Select the Setup Menus with the help of Function Codes	Format : FUNC <Function Code> <table border="1"> <thead> <tr> <th>Function code</th> <th>Setting Menu</th> </tr> </thead> <tbody> <tr> <td>0</td> <td>OVP setting</td> </tr> <tr> <td>1</td> <td>OVP Recovery</td> </tr> <tr> <td>2</td> <td>UVP Setting</td> </tr> <tr> <td>3</td> <td>UVP Recovery</td> </tr> <tr> <td>4</td> <td>UV Alarm</td> </tr> <tr> <td>5</td> <td>RS-232 Baud-rate</td> </tr> </tbody> </table>	Function code	Setting Menu	0	OVP setting	1	OVP Recovery	2	UVP Setting	3	UVP Recovery	4	UV Alarm	5	RS-232 Baud-rate						
Function code	Setting Menu																				
0	OVP setting																				
1	OVP Recovery																				
2	UVP Setting																				
3	UVP Recovery																				
4	UV Alarm																				
5	RS-232 Baud-rate																				
Query the functions No	Format: FUNC?																				
Query the setting value of the function	Format: SETT?																				
Set or adjust the value of the function	Format: SETT <value>																				

Table 34. RS-232 interface command

The following data shows the function code detail setting value.

5-3-2-1. FUN 0: OVP setting

SETT <value>	Default	Model
150 ~ 165 @100=1V	16.5V <165>	SP series-112 / 212
300 ~ 330 @100=1V	33.0V <330>	SP series-124 / 224
600 ~ 640 @100=1V	64.0V <640>	SP series-148 / 248

Table 35. OVP setting

5-3-2-2. FUN 1 : OVP Recovery

SETT <value>	Default	Model
135 ~ 145 @100=1V	14.5V <145>	SP series-112 / 212
270 ~ 290 @100=1V	29.0V <290>	SP series-124 / 224
540 ~ 580 @100=1V	58.0V <580>	SP series-148 / 248

Table 36. OVP recovery

5-3-2-3. FUN 2 : UVP setting

SETT <value>	Default	Model
105 ~ 115 @100=1V	10.5V <105>	SP series-112 / 212
210 ~ 230 @100=1V	21.0V <210>	SP series-124 / 224
420 ~ 460 @100=1V	42.0V <420>	SP series-148 / 248

Table 37. UVP setting

5-3-2-4. UVP Recovery

SETT <value>	Default	Model
125 ~ 135 @100=1V	12.5V <125>	SP series-112 / 212
250 ~ 270 @100=1V	25.0V <250>	SP series-124 / 224
500 ~ 540 @100=1V	50.0V <500>	SP series-148 / 248

Table 38. UVP recovery

5-3-2-5. FUN 4 : UV Alarm

SETT <value>	Default	Model
105 ~ 115 @100=1V	10.5V <115>	SP series-112 / 212
210 ~ 230 @100=1V	21.0V <210>	SP series-124 / 224
420 ~ 460 @100=1V	42.0V <420>	SP series-148 / 248

Table 39. UV alarm

5-3-2-6. FUN 5 : RS232 Baud rate

SETT <value>	Default	Model
0	3	600
1		1200
2		2400
3		4800
4		9600

Table 40. RS-232 baud rate

5-3-2-7. FUN 6 : Retry time

SETT <value>	Default
0	3
1	
2	
3	
4	

Table 41. retry time

6. Information

6-1. Warning



Warning! Do not open or disassemble the Inverter. Attempting to do so may cause risk of electrical shock or fire.

6-2. Warranty

We guarantee this product against defects in materials and workmanship for a period of 24 months from the date of purchase. In case you need to repair or replace any defective power inverters, please contact COTEK local distributor.

This warranty will be considered void if the unit has been misused, altered, or accidentally damaged. COTEK is not liable for anything that occurs as a result of the user's fault.

COTEK

No.33, Sec. 2, Renhe Rd., Daxi Township, Taoyuan County 33548, Taiwan (R.O.C.)

Phone : +886-3-3891999 FAX : +886-3-3802333

[http : // www.cotek.com.tw](http://www.cotek.com.tw)

2014.12._A1